



Somerset Academy / Panther Judo

2021 US Open Judo Championships

Orlando, Florida, July 23 to 25 2021

Round Robin

DATE: 24/07/2021 MAT: 1 SESSION: 2

JUVENILE -36 KG M

5 Athetes

#	Name		1	2	3	4	5	W	Points	Place
1	GOMES William	CHIEF		1	1	10	10	4	22	1
2	DEMARCO Vincent	COHE	0		10	10	10	3	30	2
3	SUVI Robert	COHE	0	0		10	10	2	20	3
4	PALMA GONZALEZ Harold	MAMB	0	0	0		0	0	0	5
5	BINYAMIN Yoav	FORT	0	0	0	10		1	10	4

Matches Order	1-2	3-4	1-5	2-3	4-5	1-3	2-5	1-4	3-5	2-4
	1	2	10	11	19	20	25	26	27	28
Score	1 / 0 (3:29) G.S.	2 / 0 (0:23)	10 / 0 (3:00)	2 / 1 (3:16) G.S.	0 / 2 (3:00)	1 / 0 (4:35) G.S.	11 / 0 (1:23)	10 / 0 (0:29)	10 / 0 (3:11) G.S.	2 / 0 (0:45)

RESULTS

1. GOMES William CHIEF
2. DEMARCO Vincent COHE
3. SUVI Robert COHE
3. BINYAMIN Yoav FORT
5. PALMA GONZALEZ Harold MAMB

Point System

Ippon / Hansoku Make	10
Wazari	1

JUVENILE
-40 KG M

8 Athetes

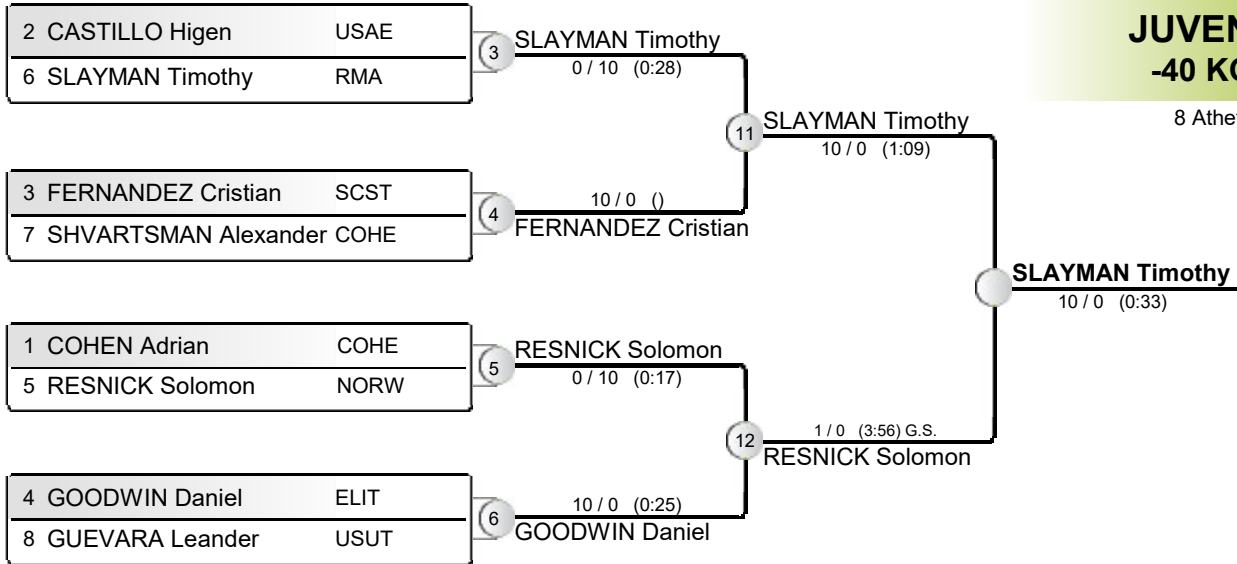

LOSER'S POOL

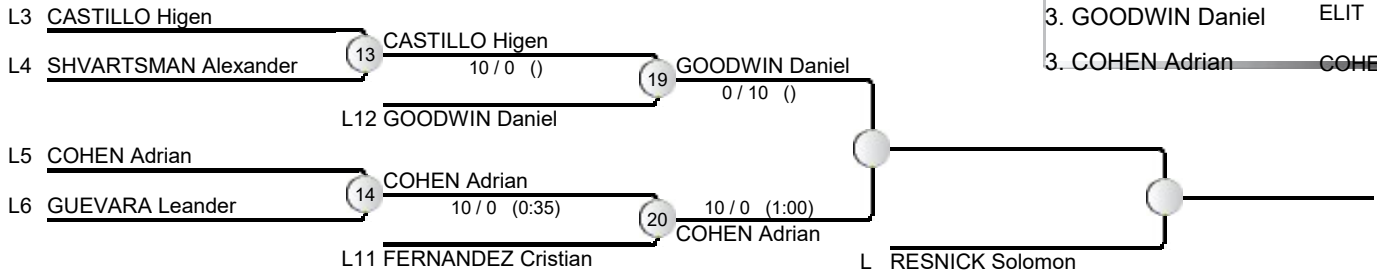

RESULTS

- 1. SLAYMAN Timothy RMA
- 2. RESNICK Solomon NORW
- 3. GOODWIN Daniel ELIT
- 3. COHEN Adrian COHE



Somerset Academy / Panther Judo

2021 US Open Judo Championships

Orlando, Florida, July 23 to 25 2021

Round Robin

DATE: 24/07/2021 MAT: 5 SESSION: 2

JUVENILE -44 KG M

5 Athetes

#	Name		1	2	3	4	5	W	Points	Place
1	KRAUSE Michael	GRPL		0	0	0	0	0	0	5
2	GARDU Pablo	LOBO	10		0	10	10	3	30	2
3	BOLDBAATAR Ethan	BGJ	10	1		10	10	4	31	1
4	YANAGI Garrett	SGJC	10	0	0		0	1	10	4
5	VASQUEZ Bryce	CHIEF	10	0	0	10		2	20	3

Matches Order	1-2	3-4	1-5	2-3	4-5	1-3	2-5	1-4	3-5	2-4
	①	②	⑨	⑩	⑰	⑱	⑳	㉔	㉕	㉖
Score	0 / 10 (0:10)	2 / 0 (0:55)	0 / 2 (1:21)	0 / 1 (3:00)	0 / 2 (0:50)	0 / 10 (0:10)	10 / 0 (0:11)	0 / 11 (1:31)	10 / 0 (2:10)	2 / 0 (0:28)

RESULTS

1. BOLDBAATAR Ethan BGJ
2. GARDU Pablo LOBO
3. VASQUEZ Bryce CHIEF
3. YANAGI Garrett SGJC
5. KRAUSE Michael GRPL

Point System

Ippon / Hansoku Make	10
Wazari	1

DATE: 24/07/2021 MAT: 2 SESSION: 3

JUVENILE
-48 KG M

3 Athetes

#	Name		1	2	3	4	5	W	Points	Place
1	TAMAI Jacob	COLL		10	0			1	10	1
2	HIGASHI Tyler	SGJC	0		10			1	10	2
3	MIRANDA Diego	KIIT	10	0				1	10	3
4										
5										

Matches Order	1-2	2-3	1-3
	17	28	33
Score	11 / 1 (3:18) G.S.	10 / 0 (0:07)	0 / 10 (6:04) G.S.

RESULTS

1. TAMAI Jacob	COLL
2. HIGASHI Tyler	SGJC
3. MIRANDA Diego	KIIT
3.	
5.	

Point System

Ippon / Hansoku Make	10
Wazari	1



Somerset Academy / Panther Judo

2021 US Open Judo Championships

Orlando, Florida, July 23 to 25 2021

Round Robin (Match-Off Place 1)

DATE: 24/07/2021 MAT: 2 SESSION: 3

JUVENILE * -48 KG M

3 Athetes

#	Name		1	2	3	4	5	W	Points	Place
1	TAMAI Jacob	COLL		10	1			2	11	1
2	HIGASHI Tyler	SGJC	0		10			1	10	2
3	MIRANDA Diego	KIIT	0	0				1	0	3
4										
5										

Matches Order	1-2	2-3	1-3
---------------	-----	-----	-----

"Modified" Double Elimination

DATE: 24/07/2021 MAT: 4 SESSION: 3

JUVENILE -53 KG M

15 Athletes

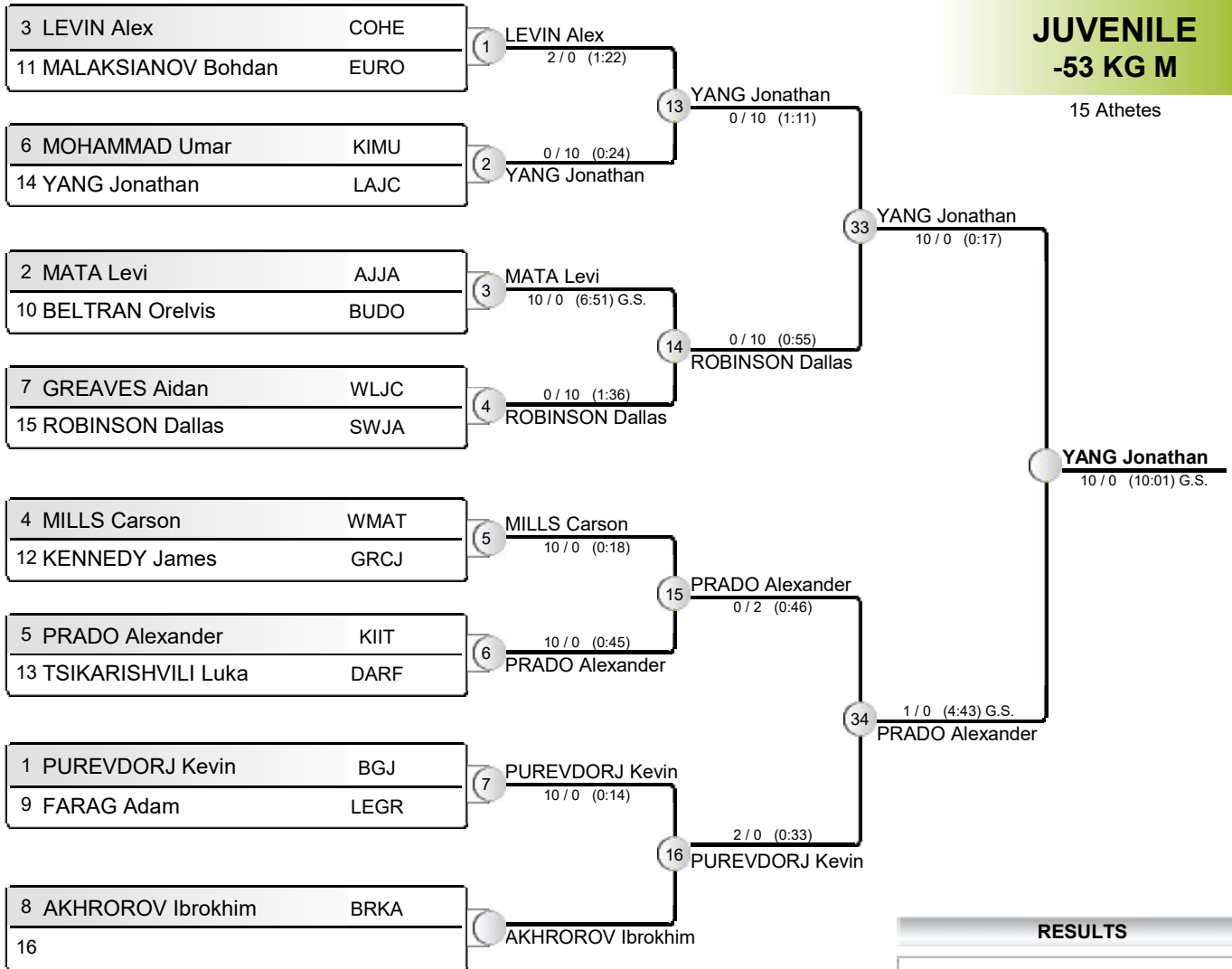

RESULTS	
1. YANG Jonathan	LAJC
2. PRADO Alexander	KIIT
3. ROBINSON Dallas	SWJA
3. LEVIN Alex	COHE

LOSER'S POOL

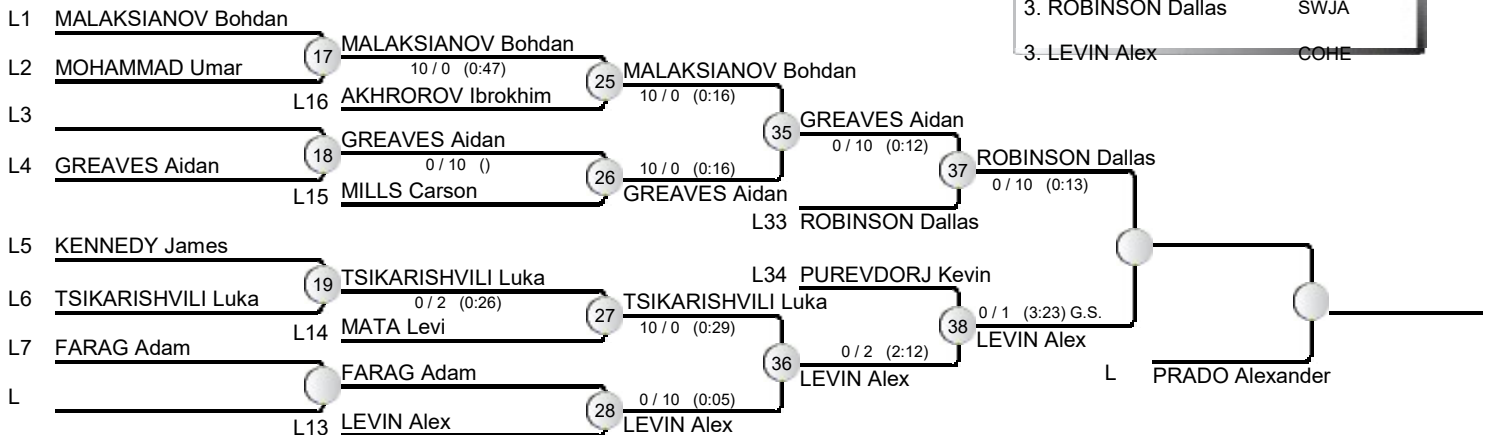

"Modified" Double Elimination

DATE: 24/07/2021 MAT: 6 SESSION: 3

JUVENILE -58 KG M

11 Athetes

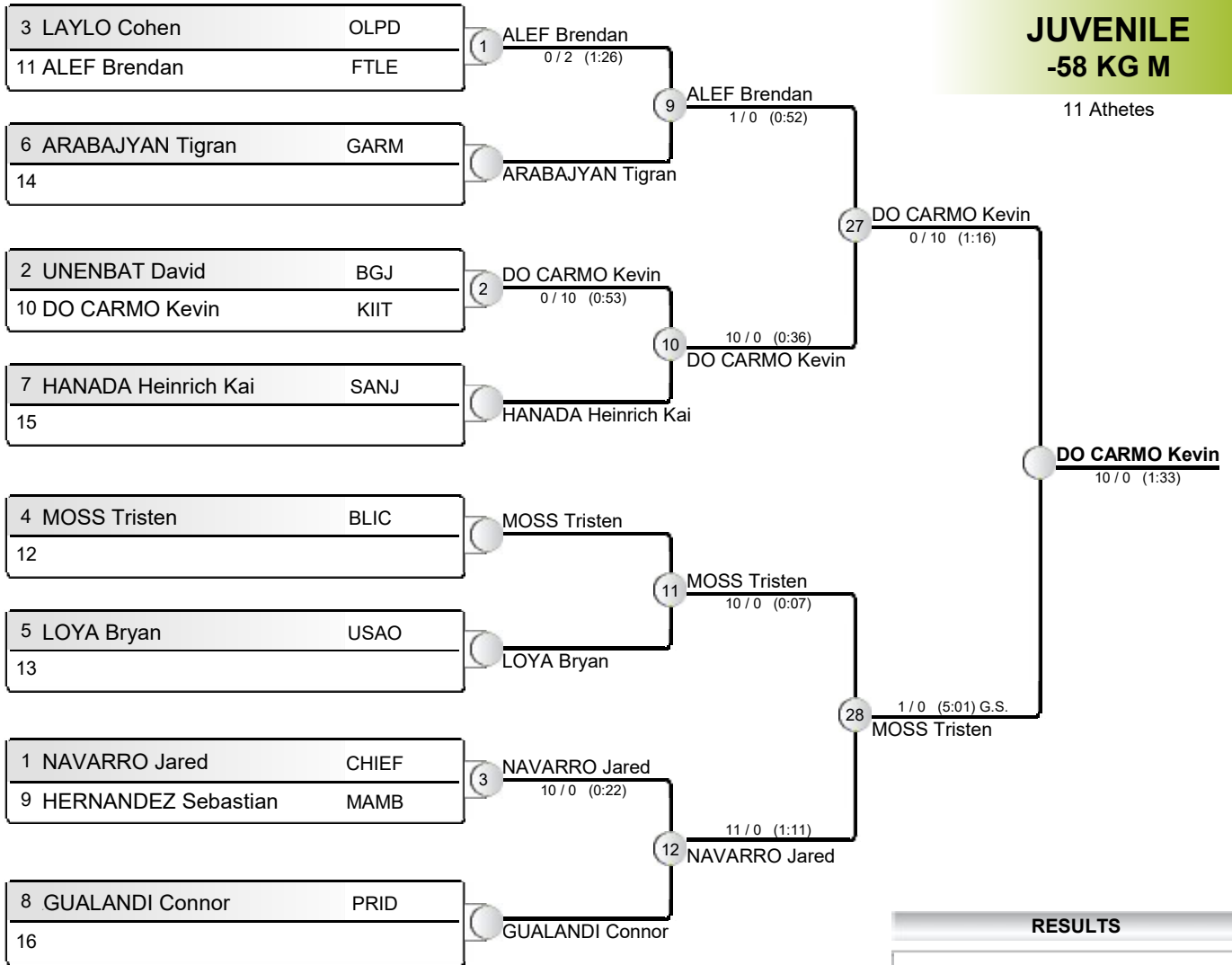

RESULTS	
1. DO CARMO Kevin	KIIT
2. MOSS Tristen	BLIC
3. UNENBAT David	BGJ
3. HANADA Heinrich Kai	SANJ

LOSER'S POOL

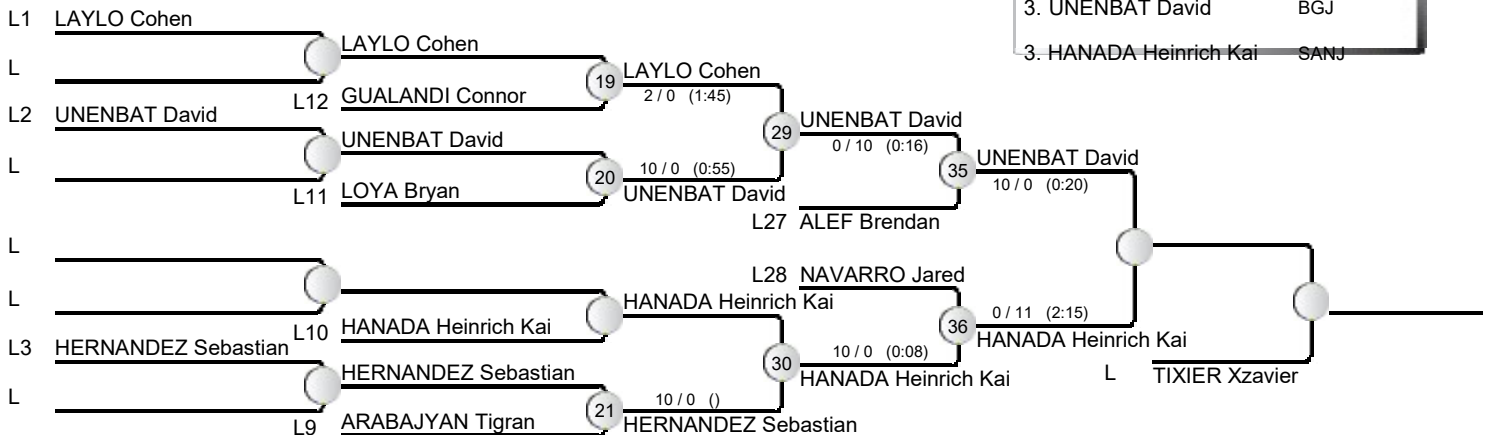

JUVENILE -64 KG M

9 Athletes

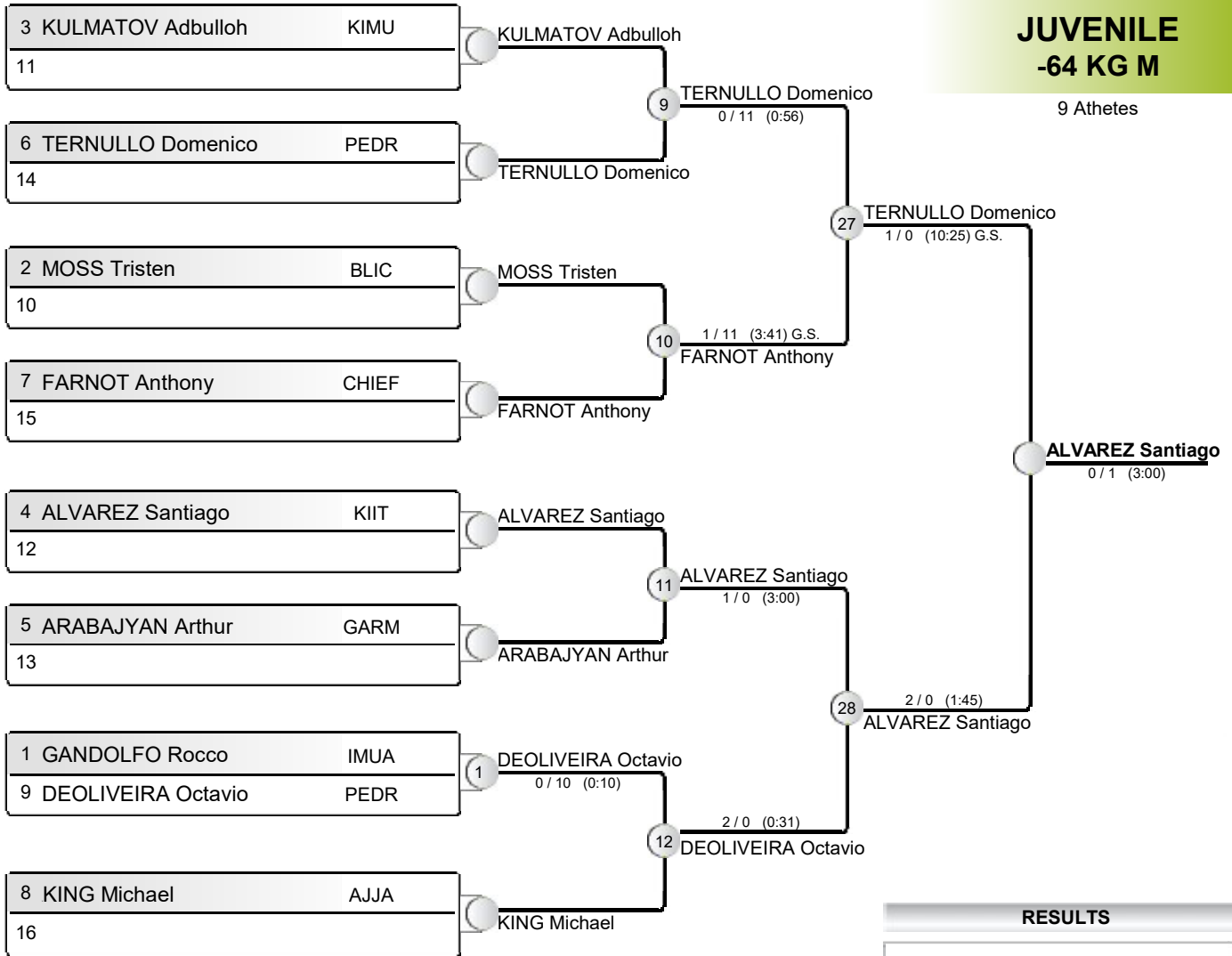

RESULTS

1. ALVAREZ Santiago	KIIT
2. TERNULLO Domenico	PEDR
3. FARNOT Anthony	CHIEF
3. DEOLIVEIRA Octavio	PEDR

LOSER'S POOL

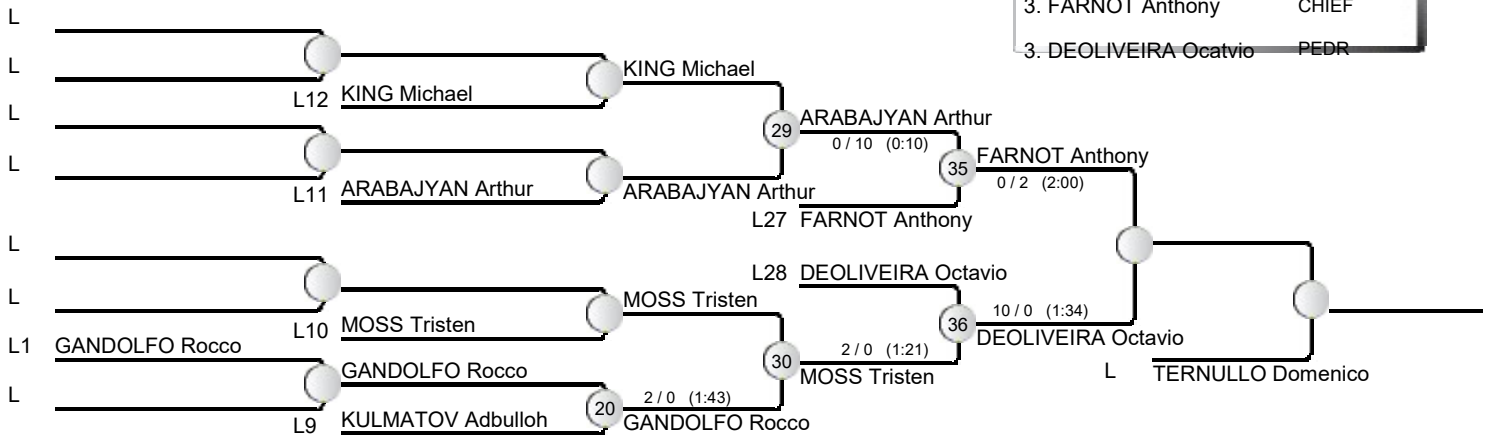

JUVENILE 64+ KG M

13 Athetes

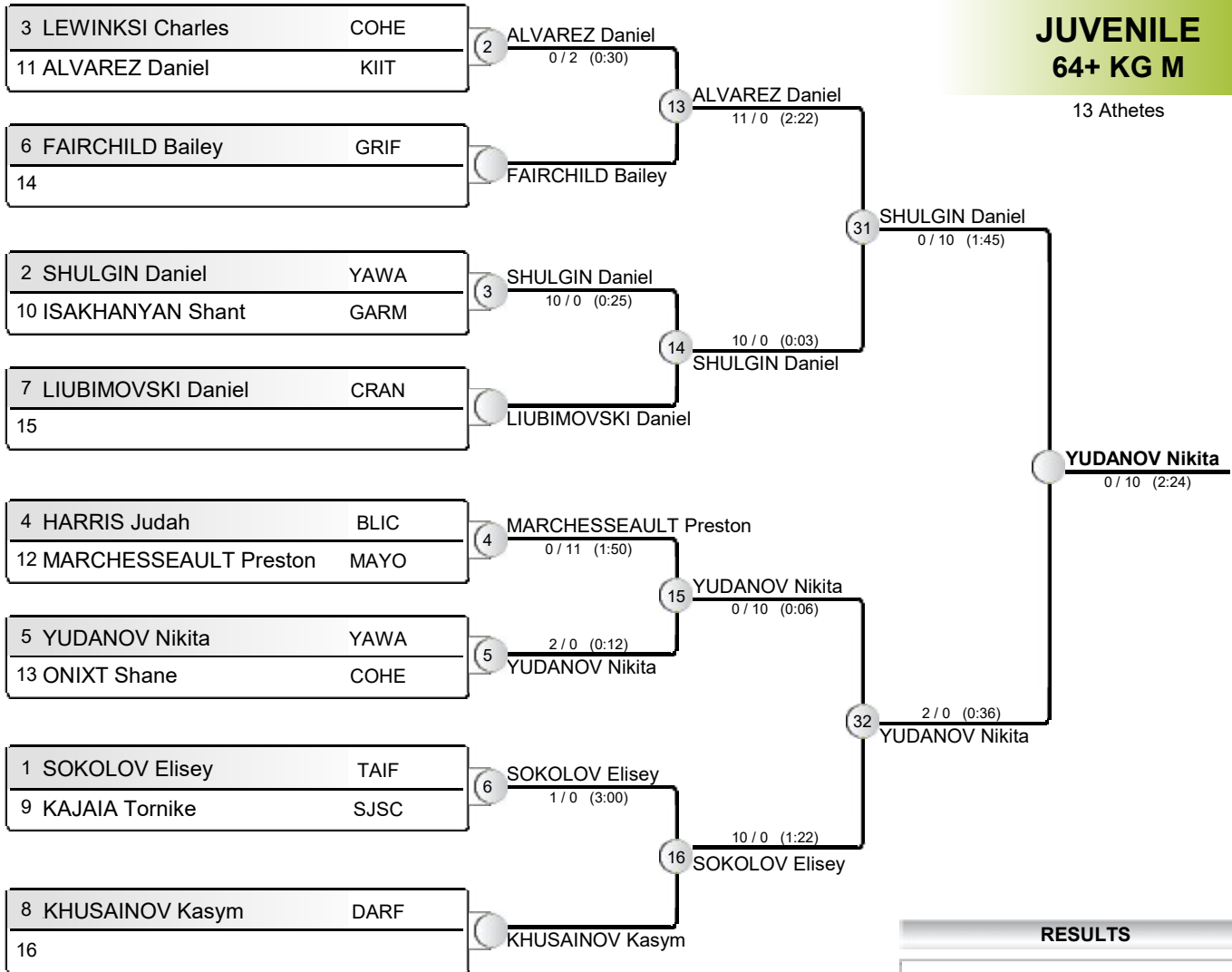

LOSER'S POOL

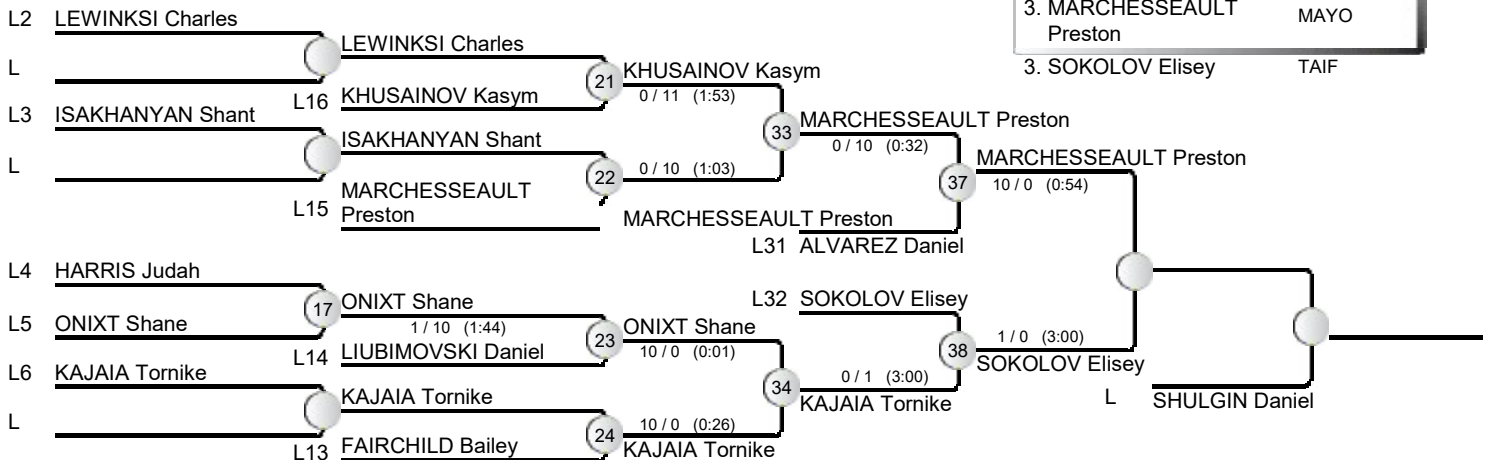

RESULTS	
1. YUDANOV Nikita	YAWA
2. SHULGIN Daniel	YAWA
3. MARCHESSEAUPT Preston	MAYO
3. SOKOLOV Elisey	TAIF